

itl boulder
THE LIGHT CENTER OF THE INDUSTRY SINCE 1955

INDEPENDENT TESTING LABORATORIES, INC.
3386 LONGHORN ROAD, BOULDER, CO 80302 USA

PHONE: (303)442-1255 • FAX: (303)449-5274 • E-MAIL: itl@itlboulder.com • WEBSITE: www.itlboulder.com

ISOFOOTCANDLE LINES OF HORIZONTAL ILLUMINATION
Values based on 20 foot mounting height.

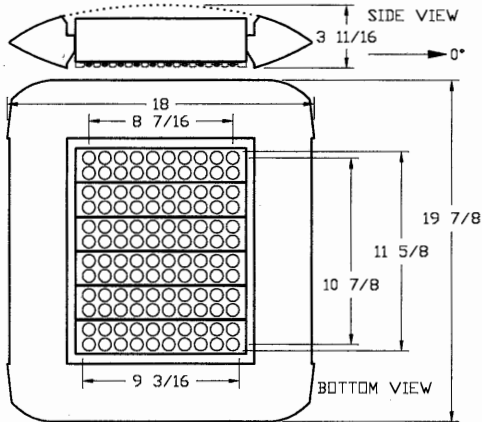

REPORT NUMBER: ITL63821
DATE: 12/08/09
PREPARED FOR: BETA LIGHTING, INC.
CATALOG NUMBER: BXAL1212C-UW (350mA)
LUMINAIRE: EXTRUDED BLACK PAINTED METAL HOUSING, FABRICATED BLACK PAINTED METAL BALLAST MOUNTING PLATE, CAST BLACK PAINTED METAL END CAPS, FORMED PERFORATED METAL TOP, SIX EXTRUDED FINNED METAL HEAT SINKS, EACH HEAT SINK CONTAINS ONE CIRCUIT BOARD WITH 20 LEDS, CAST BLACK PAINTED METAL TRIM PLATE, ONE CLEAR PLASTIC NON-INTEGRAL LENS BELOW EACH LED
LAMP: ONE HUNDRED TWENTY WHITE LIGHT EMITTING DIODES (LEDS), VERTICAL BASE-UP POSITION.
TOTAL INPUT WATTS = 147.2 AT 240.0 VOLTS
LED DRIVER: BETA LED CE366X01R0
NOTE: DATA SHOWN IS ABSOLUTE FOR THE SAMPLE PROVIDED AT RATED INPUT VOLTAGE (240VAC, 60Hz) TO THE LED DRIVER. CLIENT STATES LEDS HAVE BEEN SEASONED FOR A MINIMUM OF 100 HOURS.
TEST PROCEDURE: IESNA LM-79-08
TEST DISTANCE = 25.25 FEET

IES Classification: Medium, Type II

--- 1/2 Maximum Candela trace

X Maximum Candela point

Checked *R. Huns*

Approved *R. Beattie*

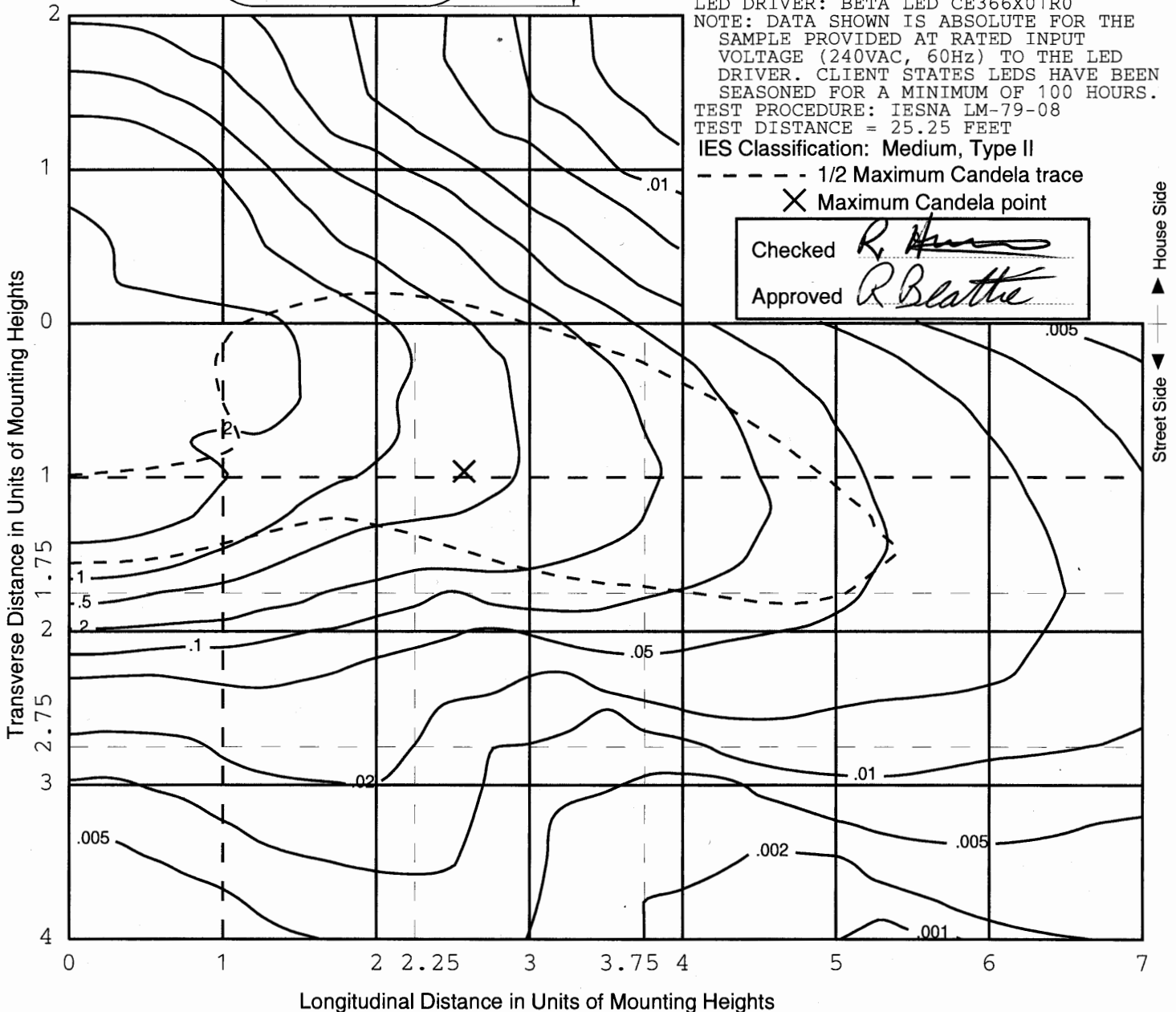

THIS REPORT IS BASED ON PUBLISHED INDUSTRY PROCEDURES. FIELD PERFORMANCE MAY DIFFER FROM LABORATORY PERFORMANCE.

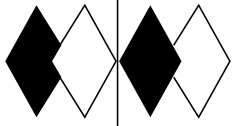

itl boulder
 THE LIGHT CENTER OF THE INDUSTRY SINCE 1955

INDEPENDENT TESTING LABORATORIES, INC.
 3386 LONGHORN ROAD, BOULDER, CO 80302 USA

PHONE: (303)442-1255 • FAX: (303)449-5274 • E-MAIL: itl@itlboulder.com • WEBSITE: www.itlboulder.com

REPORT NUMBER: ITL63821

DATE: 12/08/09

PREPARED FOR: BetaLED a Division of Ruud Lighting

CATALOG NUMBER: BXAL1212C-U(350mA)/ARE-EDG-2M-DA-12-C-UL

LUMINAIRE: EXTRUDED BLACK PAINTED

METAL HOUSING, FABRICATED BLACK
 PAINTED METAL BALLAST MOUNTING PLATE,
 CAST BLACK PAINTED METAL END CAPS,
 FORMED PERFORATED METAL TOP, SIX
 EXTRUDED FINNED METAL HEAT SINKS,
 EACH HEAT SINK CONTAINS ONE CIRCUIT
 BOARD WITH 20 LEDS, CAST BLACK
 PAINTED METAL TRIM PLATE, ONE CLEAR
 PLASTIC NON-INTEGRAL LENS BELOW EACH
 LED.

LAMP: ONE HUNDRED TWENTY WHITE LIGHT
 EMITTING DIODES (LEDS), VERTICAL
 BASE-UP POSITION.

TOTAL INPUT WATTS = 147.2 AT 240.0
 VOLTS

LED DRIVER: BETA LED CE366X01R0

NOTE: DATA SHOWN IS ABSOLUTE FOR THE
 SAMPLE PROVIDED AT RATED INPUT
 VOLTAGE (240VAC, 60Hz) TO THE LED
 DRIVER. CLIENT STATES LEDS HAVE BEEN
 SEASONED FOR A MINIMUM OF 100 HOURS.

TEST PROCEDURE: IESNA LM-79-08

TEST DISTANCE = 25.25 FEET

MAXIMUM PLANE AND MAXIMUM CONE PLOTS OF CANDELA

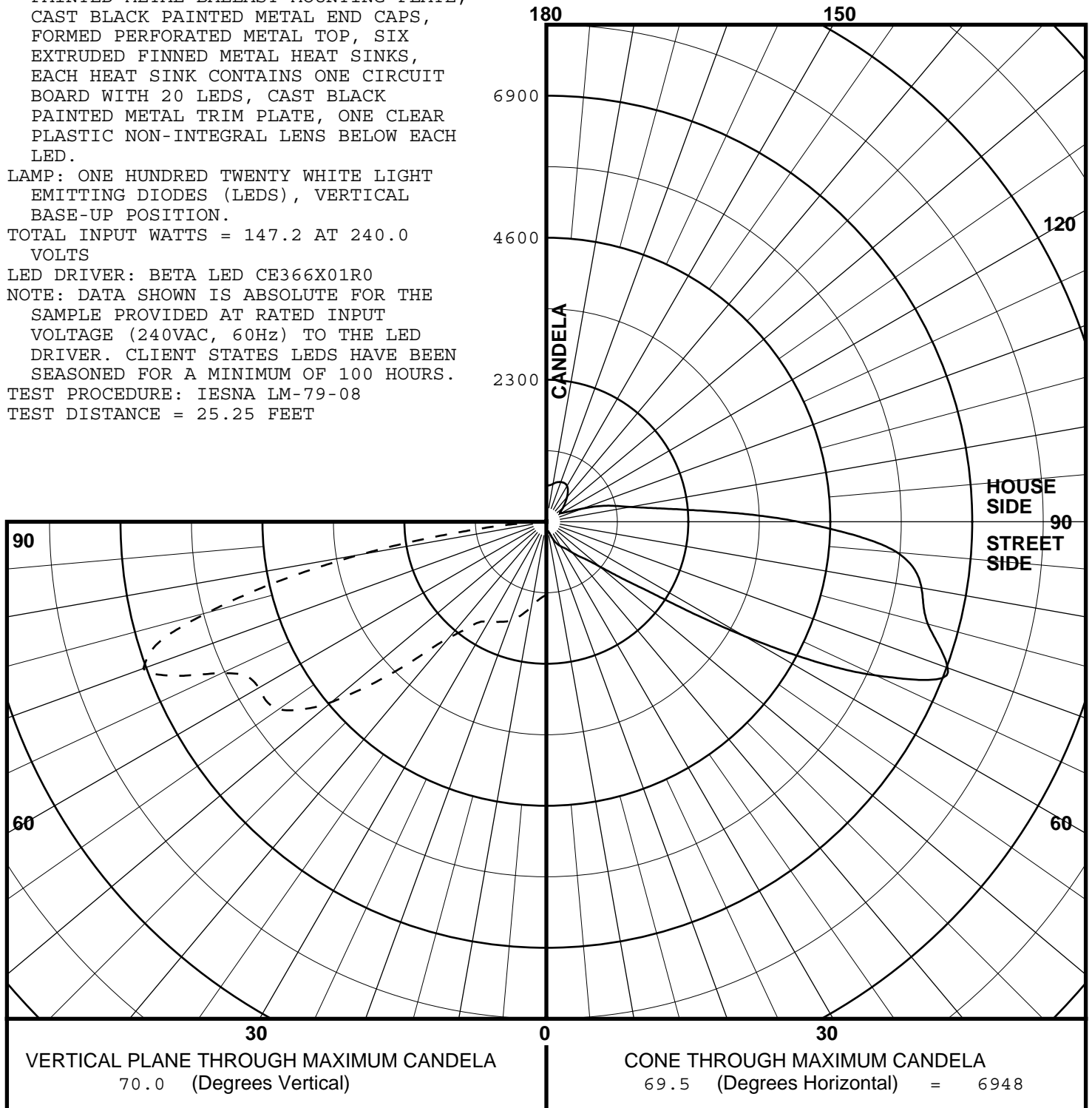

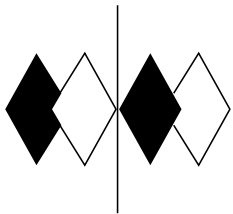

REPORT NUMBER: ITL63821
 DATE: 12/08/09
 PREPARED FOR: BetaLED a Division of Ruud Lighting

COEFFICIENTS OF UTILIZATION AND FLUX DISTRIBUTION

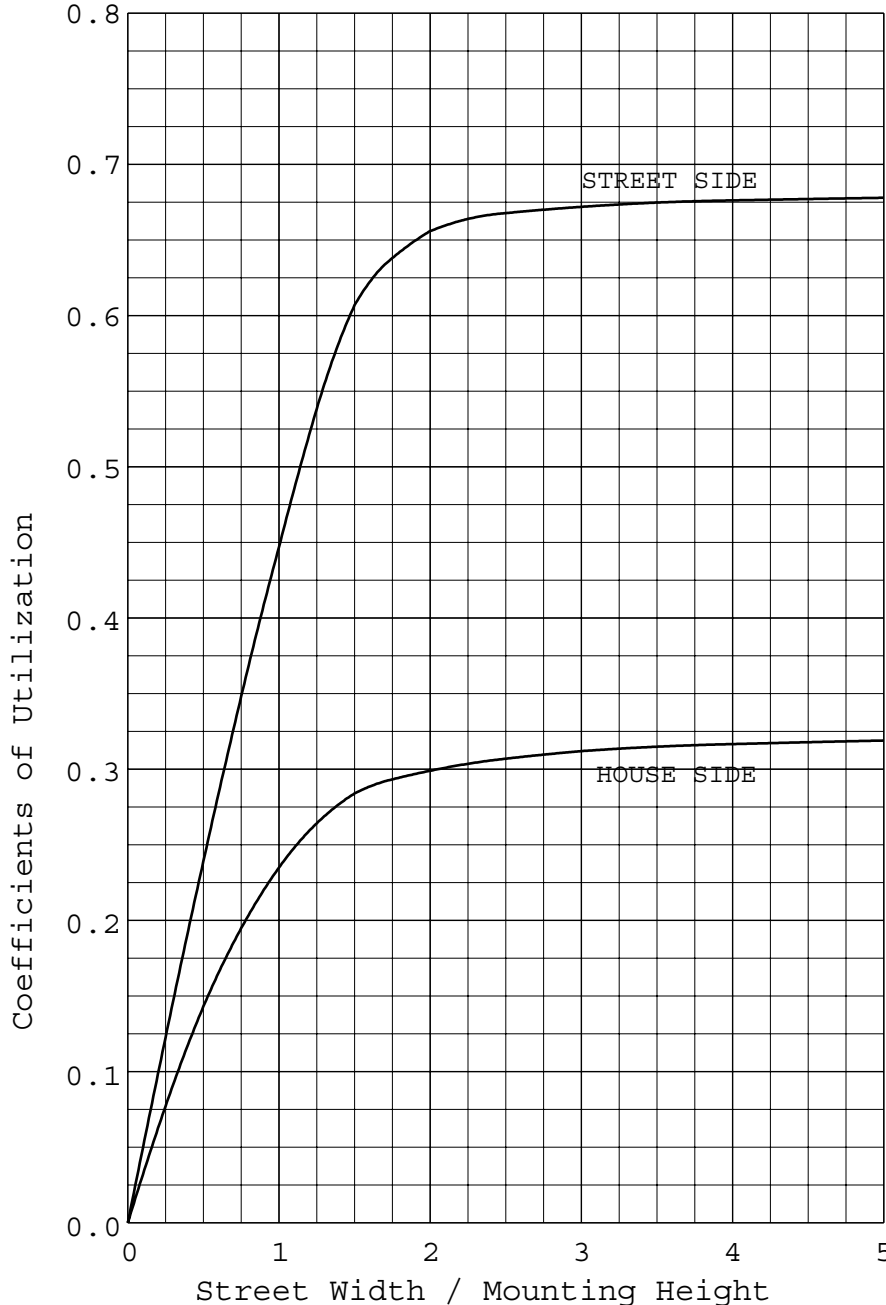

	LUMENS	PERCENT OF FIXTURE
DOWNWARD STREET SIDE	7035.	67.9
DOWNWARD HOUSE SIDE	3320.	32.1
DOWNWARD TOTAL	10355.	100.0
UPWARD STREET SIDE	0.	0.0
UPWARD HOUSE SIDE	0.	0.0
UPWARD TOTAL	0.	0.0
TOTAL FLUX	10355.	100.0
EFFICACY = 70.3 Lm/W		

ALL CANDELA AND LUMENS IN THIS REPORT ARE BASED ON ABSOLUTE PHOTOMETRY. THE COEFFICIENT OF UTILIZATION VALUES ARE BASED ON THE TOTAL ABSOLUTE LUMEN OUTPUT OF THIS LUMINAIRE SAMPLE.

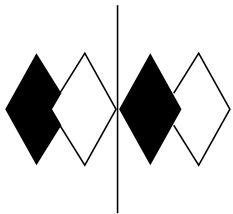

itl boulder
THE LIGHT CENTER OF THE INDUSTRY SINCE 1955

INDEPENDENT TESTING LABORATORIES, INC.
3386 LONGHORN ROAD, BOULDER, CO 80302 USA

PHONE: (303)442-1255 • FAX: (303)449-5274 • E-MAIL: itl@itlboulder.com • WEBSITE: www.itlboulder.com

REPORT NUMBER: ITL63821

DATE: 12/08/09

PREPARED FOR: BetaLED a Division of Ruud Lighting

FLUX DISTRIBUTION BY SOLID ANGLE

(PER IESNA TM-15-07, LUMINAIRE CLASSIFICATION
SYSTEM FOR OUTDOOR LUMINAIRES)

	LUMENS	PERCENT OF FIXTURE
FORWARD LIGHT	7035.	67.9
FL (0- 30)		6.7
FM (30- 60)		36.8
FH (60- 80)		23.0
FVH(80- 90)		1.5
BACK LIGHT	3320.	32.1
BL (0- 30)		4.8
BM (30- 60)		19.3
BH (60- 80)		7.8
BVH(80- 90)		0.1
UPLIGHT	0.	0.0
UL (90-100)		0.0
UH (100-180)		0.0
TRAPPED LIGHT	0.	0.0
TOTAL FLUX	10355.	100.0

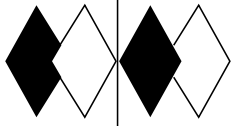

itl boulder

THE LIGHT CENTER OF THE INDUSTRY SINCE 1955

INDEPENDENT TESTING LABORATORIES, INC.
3386 LONGHORN ROAD, BOULDER, CO 80302 USA

PHONE: (303)442-1255 • FAX: (303)449-5274 • E-MAIL: itl@itlboulder.com • WEBSITE: www.itlboulder.com

REPORT NUMBER: ITL63821

DATE: 12/08/09

PREPARED FOR: BetaLED a Division of Ruud Lighting

CANDELA TABULATION

	STREET SIDE			LATERAL ANGLE								
	0.0	5.0	15.0	25.0	35.0	45.0	55.0	65.0	69.5	75.0	85.0	
	180.0	0.	0.	0.	0.	0.	0.	0.	0.	0.	0.	
	175.0	0.	0.	0.	0.	0.	0.	0.	0.	0.	0.	
	165.0	0.	0.	0.	0.	0.	0.	0.	0.	0.	0.	
	155.0	0.	0.	0.	0.	0.	0.	0.	0.	0.	0.	
	145.0	0.	0.	0.	0.	0.	0.	0.	0.	0.	0.	
	135.0	0.	0.	0.	0.	0.	0.	0.	0.	0.	0.	
	125.0	0.	0.	0.	0.	0.	0.	0.	0.	0.	0.	
	115.0	0.	0.	0.	0.	0.	0.	0.	0.	0.	0.	
	105.0	0.	0.	0.	0.	0.	0.	0.	0.	0.	0.	
	95.0	0.	0.	0.	0.	0.	0.	0.	0.	0.	0.	
	92.5	0.	0.	0.	0.	0.	0.	0.	0.	0.	0.	
	90.0	0.	0.	0.	0.	0.	0.	0.	0.	0.	0.	
	87.5	2.	2.	3.	9.	14.	7.	11.	69.	168.	220.	103.
	85.0	6.	7.	13.	40.	68.	22.	38.	362.	781.	942.	457.
V	82.5	22.	23.	37.	88.	139.	54.	85.	874.	1725.	1972.	950.
E	80.0	37.	39.	65.	136.	228.	105.	160.	1640.	3059.	3434.	1735.
R	77.5	51.	53.	89.	192.	340.	178.	296.	2688.	4440.	4861.	2766.
T	75.0	65.	66.	120.	259.	428.	286.	549.	3968.	5681.	5967.	3903.
I	72.5	95.	97.	155.	320.	470.	475.	1033.	5132.	6630.	6477.	4918.
C	70.3	144.	138.	185.	372.	511.	738.	1674.	5849.	6924.	6426.	5534.
A	70.0<<	158.	153.	191.	382.	524.	823.	1837.	5888.	6948.	6400.	5707.
L	67.5	253.	251.	286.	482.	752.	1493.	2798.	6036.	6518.	5905.	6080.
	65.0	391.	390.	459.	806.	1391.	2482.	3628.	5756.	5802.	5390.	5924.
A	62.5	958.	977.	1150.	1728.	2521.	3454.	4218.	5434.	5442.	5090.	5404.
N	60.0	2183.	2215.	2468.	3018.	3667.	4215.	4426.	5200.	5379.	5042.	4952.
G	57.5	3495.	3529.	3676.	4077.	4479.	4587.	4100.	5078.	5388.	5054.	4688.
L	55.0	4288.	4311.	4440.	4689.	4804.	4342.	3528.	4908.	5290.	5001.	4509.
E	52.5	4663.	4675.	4728.	4757.	4490.	3668.	3042.	4585.	4992.	4803.	4400.
	50.0	4514.	4516.	4470.	4280.	3806.	3053.	2695.	4116.	4543.	4505.	4220.
	47.5	4013.	4014.	3927.	3668.	3207.	2631.	2426.	3543.	3956.	4055.	3901.
	45.0	3548.	3553.	3461.	3189.	2771.	2352.	2213.	2994.	3376.	3567.	3560.
	42.5	3159.	3158.	3063.	2820.	2471.	2151.	2049.	2535.	2828.	3077.	3233.
	40.0	2845.	2842.	2757.	2541.	2240.	1985.	1905.	2217.	2451.	2731.	2988.
	37.5	2539.	2536.	2456.	2259.	2005.	1833.	1821.	2044.	2221.	2489.	2786.
	35.0	2263.	2256.	2176.	2020.	1843.	1766.	1804.	1918.	2025.	2273.	2609.
	30.0	1875.	1869.	1824.	1750.	1704.	1728.	1829.	1816.	1872.	2073.	2352.
	25.0	1678.	1675.	1663.	1645.	1651.	1732.	1833.	1720.	1788.	1930.	2037.
	20.0	1543.	1545.	1545.	1564.	1617.	1709.	1680.	1629.	1704.	1763.	1740.
	15.0	1433.	1438.	1459.	1507.	1573.	1563.	1489.	1532.	1565.	1569.	1497.
	10.0	1430.	1432.	1431.	1407.	1366.	1338.	1358.	1392.	1397.	1386.	1321.
	5.0	1221.	1222.	1226.	1234.	1246.	1259.	1265.	1263.	1257.	1249.	1217.
	0.0	1180.	1180.	1180.	1180.	1180.	1180.	1180.	1180.	1180.	1180.	1180.

||
PLANE OF MAXIMUM CANDELA

CONE OF MAXIMUM CANDELA

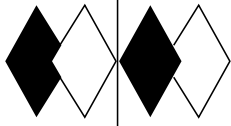

itl boulder
THE LIGHT CENTER OF THE INDUSTRY SINCE 1955

INDEPENDENT TESTING LABORATORIES, INC.
 3386 LONGHORN ROAD, BOULDER, CO 80302 USA

PHONE: (303)442-1255 • FAX: (303)449-5274 • E-MAIL: itl@itlboulder.com • WEBSITE: www.itlboulder.com

REPORT NUMBER: ITL63821

DATE: 12/08/09

PREPARED FOR: BetaLED a Division of Ruud Lighting

CANDELA TABULATION

	HOUSE SIDE		LATERAL ANGLE								
	90.0	95.0	105.0	115.0	125.0	135.0	145.0	155.0	165.0	175.0	180.0
180.0	0.	0.	0.	0.	0.	0.	0.	0.	0.	0.	0.
175.0	0.	0.	0.	0.	0.	0.	0.	0.	0.	0.	0.
165.0	0.	0.	0.	0.	0.	0.	0.	0.	0.	0.	0.
155.0	0.	0.	0.	0.	0.	0.	0.	0.	0.	0.	0.
145.0	0.	0.	0.	0.	0.	0.	0.	0.	0.	0.	0.
135.0	0.	0.	0.	0.	0.	0.	0.	0.	0.	0.	0.
125.0	0.	0.	0.	0.	0.	0.	0.	0.	0.	0.	0.
115.0	0.	0.	0.	0.	0.	0.	0.	0.	0.	0.	0.
105.0	0.	0.	0.	0.	0.	0.	0.	0.	0.	0.	0.
95.0	0.	0.	0.	0.	0.	0.	0.	0.	0.	0.	0.
92.5	0.	0.	0.	0.	0.	0.	0.	0.	0.	0.	0.
90.0	0.	0.	0.	0.	0.	0.	0.	0.	0.	0.	0.
87.5	27.	10.	6.	5.	3.	2.	2.	1.	1.	0.	0.
85.0	133.	31.	10.	7.	5.	4.	3.	3.	3.	2.	3.
V 82.5	314.	76.	20.	16.	17.	17.	16.	13.	10.	9.	10.
E 80.0	665.	180.	46.	31.	37.	43.	64.	102.	150.	193.	204.
R 77.5	1226.	379.	102.	75.	109.	184.	300.	422.	517.	568.	575.
T 75.0	2111.	816.	212.	117.	176.	316.	480.	602.	645.	623.	616.
I 72.5	3125.	1498.	529.	194.	221.	388.	573.	680.	670.	605.	593.
C 70.3	3822.	2051.	895.	325.	266.	423.	636.	691.	663.	594.	582.
A 70.0<<	4080.	2245.	1005.	376.	278.	429.	608.	691.	662.	594.	583.
L 67.5	4779.	2913.	1443.	650.	342.	458.	616.	683.	651.	597.	589.
65.0	5045.	3340.	1706.	911.	454.	495.	621.	687.	678.	640.	631.
A 62.5	4902.	3523.	1872.	1204.	698.	640.	725.	790.	813.	807.	805.
N 60.0	4571.	3519.	2034.	1572.	1160.	1030.	1056.	1087.	1118.	1143.	1148.
G 57.5	4279.	3381.	2128.	1902.	1676.	1559.	1524.	1503.	1501.	1514.	1518.
L 55.0	4074.	3185.	2052.	2010.	1974.	1938.	1915.	1881.	1828.	1796.	1791.
E 52.5	3898.	2972.	1853.	1923.	2006.	2078.	2130.	2102.	2028.	1958.	1948.
50.0	3670.	2744.	1613.	1730.	1885.	2016.	2141.	2150.	2066.	1988.	1976.
47.5	3394.	2531.	1397.	1510.	1701.	1852.	1993.	2048.	1989.	1931.	1917.
45.0	3144.	2372.	1239.	1314.	1506.	1666.	1788.	1866.	1870.	1835.	1827.
42.5	2932.	2271.	1140.	1158.	1331.	1487.	1606.	1672.	1719.	1742.	1743.
40.0	2777.	2221.	1113.	1052.	1200.	1343.	1465.	1545.	1600.	1640.	1646.
37.5	2640.	2199.	1155.	986.	1108.	1245.	1370.	1464.	1533.	1578.	1587.
35.0	2525.	2203.	1241.	961.	1045.	1178.	1303.	1403.	1475.	1517.	1526.
30.0	2320.	2131.	1431.	1039.	974.	1061.	1179.	1277.	1348.	1384.	1389.
25.0	2034.	1944.	1534.	1169.	1030.	988.	1036.	1111.	1167.	1198.	1201.
20.0	1720.	1682.	1496.	1238.	1078.	1034.	1000.	991.	1006.	1021.	1024.
15.0	1457.	1418.	1325.	1212.	1083.	993.	960.	949.	948.	949.	950.
10.0	1283.	1242.	1170.	1097.	1028.	969.	924.	896.	881.	874.	875.
5.0	1200.	1177.	1133.	1086.	1041.	1002.	970.	947.	933.	925.	926.
0.0	1180.	1180.	1180.	1180.	1180.	1180.	1180.	1180.	1180.	1180.	1180.

CONE OF MAXIMUM CANDELA